

Net-Zero-CO₂ by 2050 is NOT Enough (!)

Jonas Huber, Johann W. Kolar, et al.

Swiss Federal Institute of Technology (ETH) Zurich
Power Electronic Systems Laboratory
www.pes.ee.ethz.ch



September 28, 2023



Let's Talk About the “Elephant in the Room”

J. Huber, J. W. Kolar, L. Imperiali, D. Menzi, F. Musil*



* Fronius International GmbH, Austria
Swiss Federal Institute of Technology (ETH) Zurich
Power Electronic Systems Laboratory
www.pes.ee.ethz.ch

September 28, 2023



Outline



- ▶ *Decarbonization*
- ▶ *Internet of E-Energy*
- ▶ *The Elephant in the Room*
- ▶ *Design for Circularity*
- ▶ *Power Electronics 5.0*

The Challenge

■ Global Energy Flows — 2021

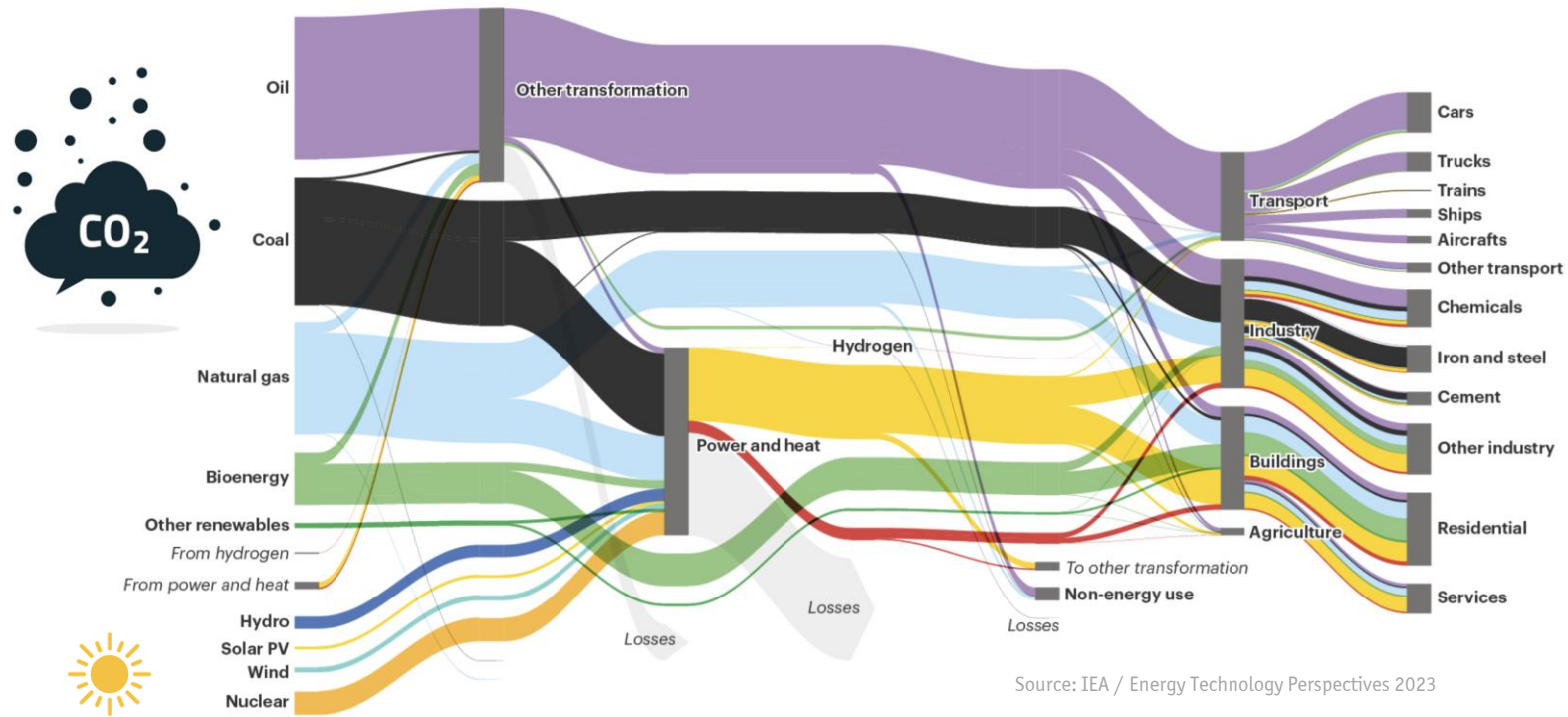

■ Large Share of Fossil Fuels (!)

Decarbonization / Defossilization

- "Net-Zero" Emissions by 2050 & Gap to be Closed
- 50 GtCO_{2eq} Global Greenhouse Gas Emissions / Year → 280 GtCO₂ Budget Left for 1.5°C Limit

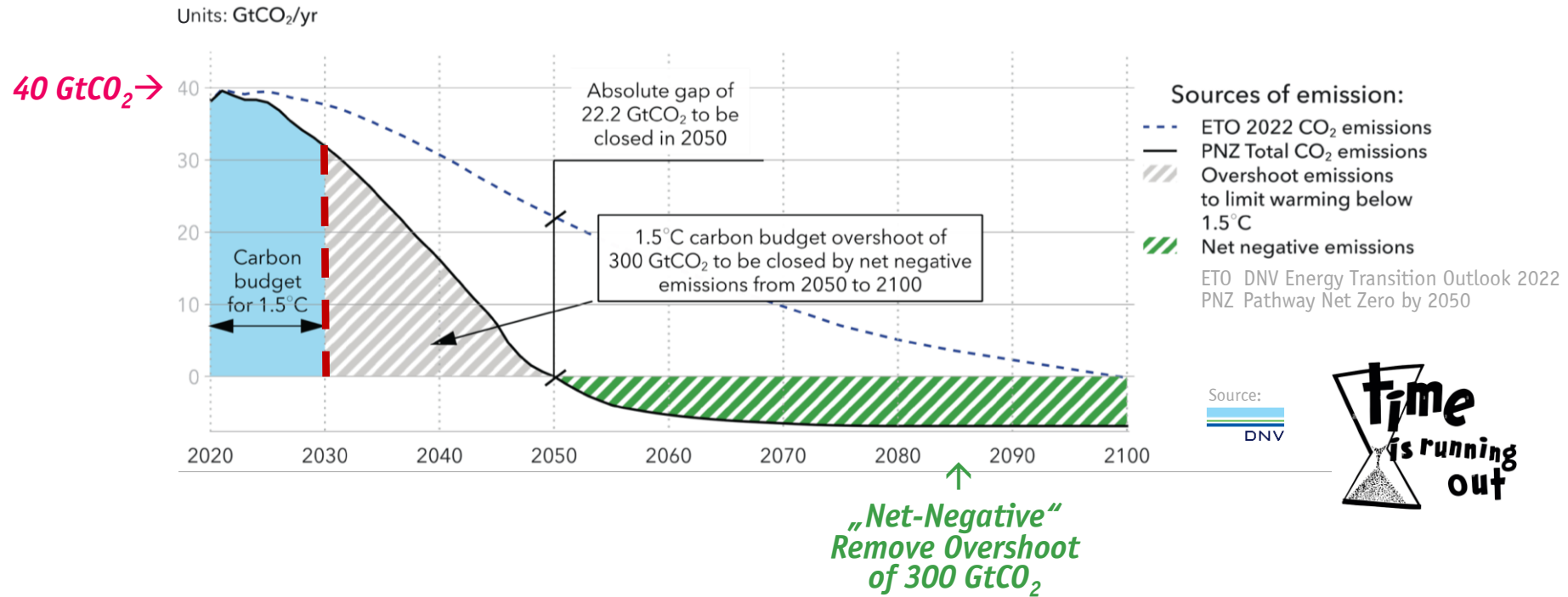

- Challenge of Stepping Back from Oil & Gas
- Human History — Transition from Lower to Higher Energy Density Fuel — Wood → Coal → Oil & Gas

Energy Independence / Security of Supply

■ Global Oil Trade (2016) — High Import Dependency of Leading Economies

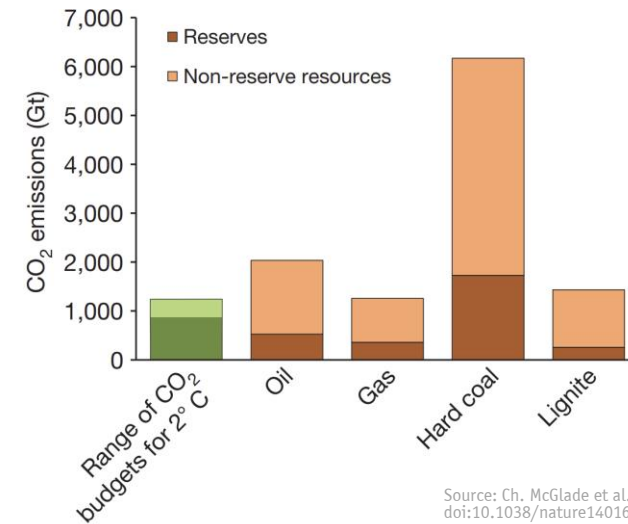
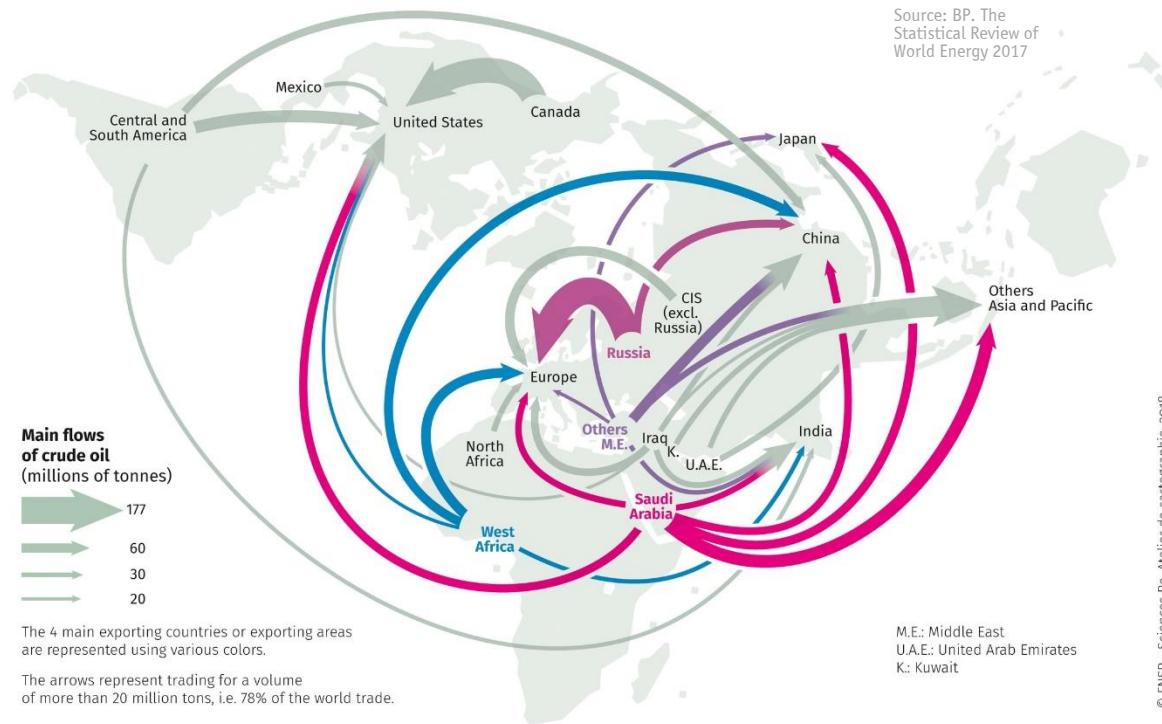

- **2°C Target → Globally, 30% of Oil Reserves | 50% Gas Reserves | > 80% Coal Reserves Should Remain Unused (!)**
- **“The Stone Age Didn't End for Lack of Stone — The Oil Age will End Long Before the World Runs Out of Oil”**

The Opportunity

(2009) 16 TW-yr  16 TW-yr per year  27 TW-yr (2050)

Renewable energy resources per year

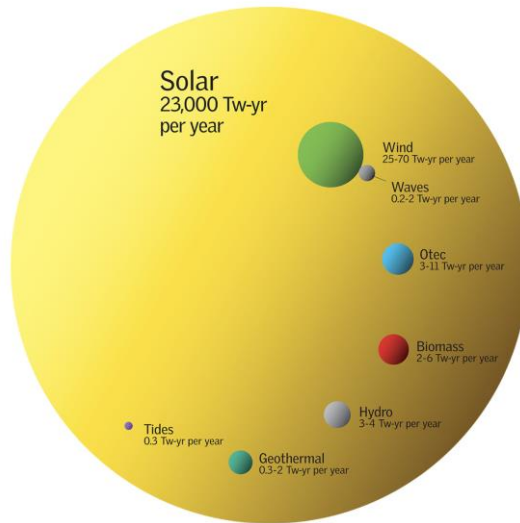

100% Conv. Efficiency
Excl. Oceans

Note: Graphical Representation Assumes Spheres Not Circles

Primary Consumption: 16 TW-yr → 27 TW-yr
Final Consumption: 11 TW-yr → 15 TW-yr

Source: R. Perez et al., IEA SHC Program Solar Update (2009)

Fossil energy resources - total reserve left on earth



Global Distribution of Solar & Wind Resources

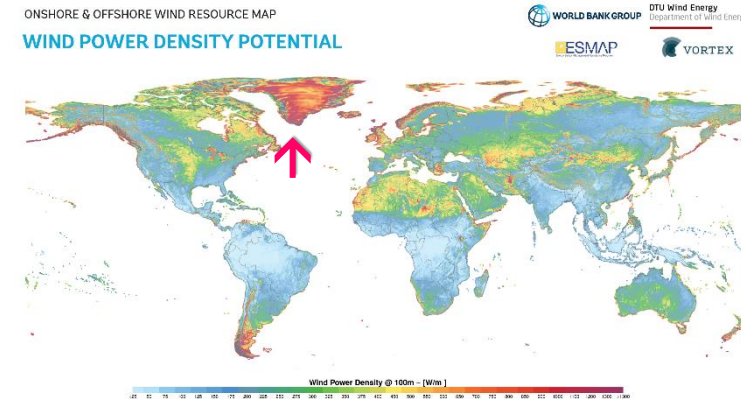
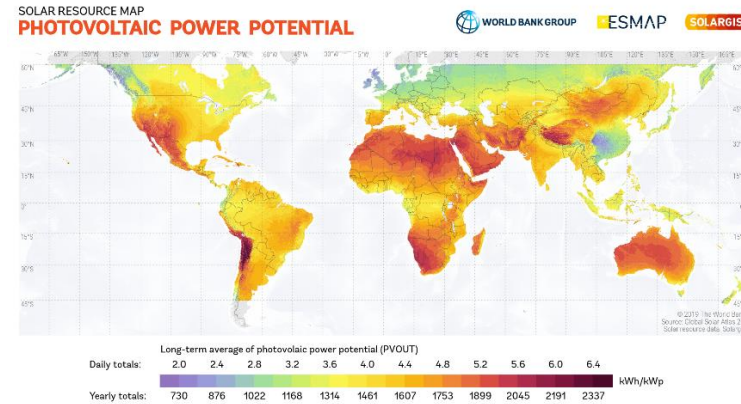

The Approach

- Outlook of Global Cumulative Installations Until 2050 / Add. 1000 GW Off-Shore Wind Power
- In 2050 Deployment of 370 GW/Year (PV) & 200 GW/Year (On-Shore Wind) incl. Replacements

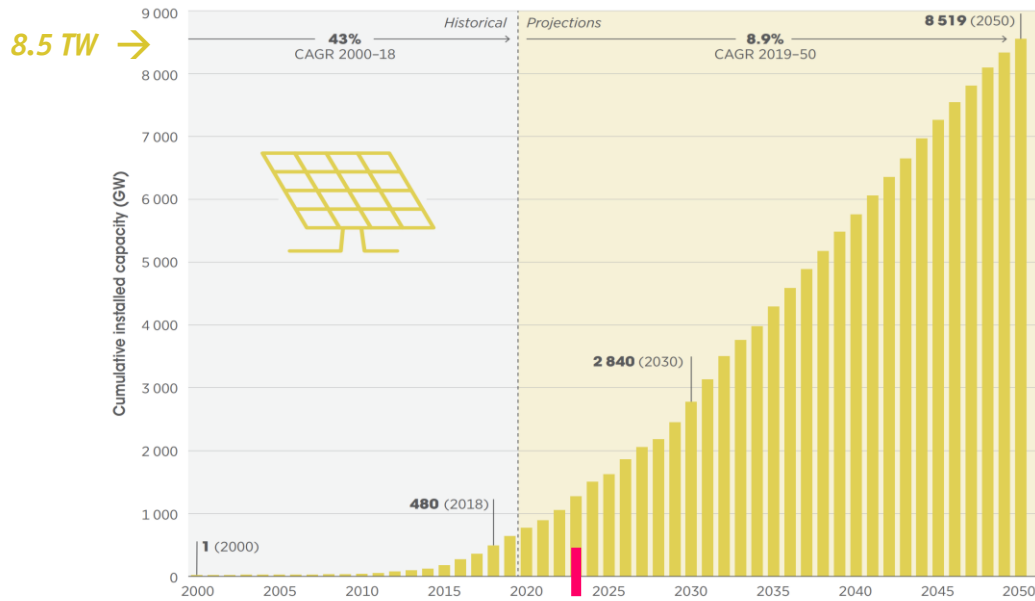

Sources: Historical values based on IRENA's renewable energy statistics (IRENA, 2019c) and future projections based on IRENA's analysis (2019a).

- CAGR of $\approx 9\%$ up to 2050 → 8500 GW

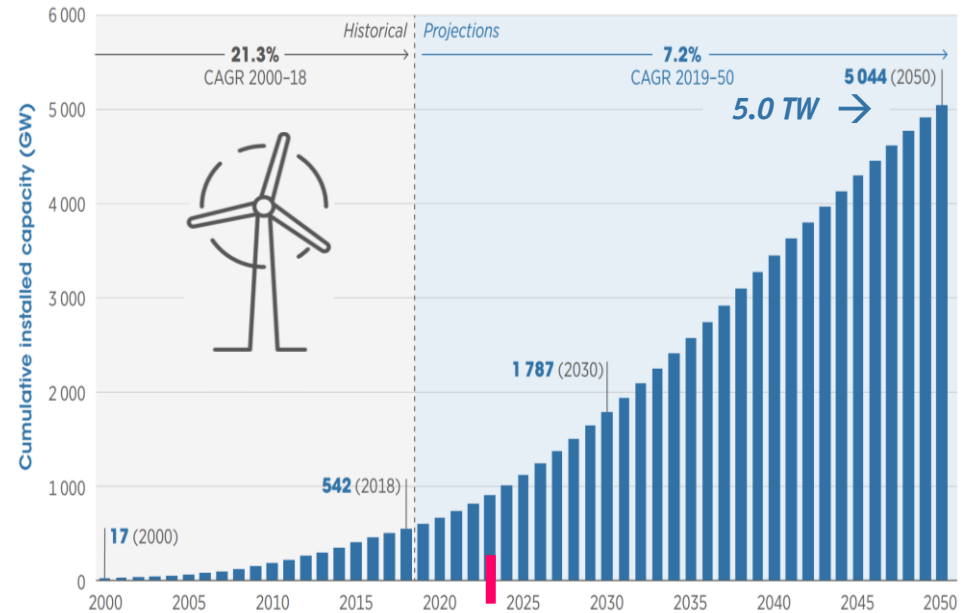

Source: Historical values based on IRENA's renewable capacity statistics (IRENA, 2019d) and future projections based on IRENA analysis (IRENA, 2019a).

- CAGR of $\approx 7\%$ up to 2050 → 5000 GW

Net-Zero CO₂ by 2050

Global Energy Flows — 2050 / Net-Zero Scenario

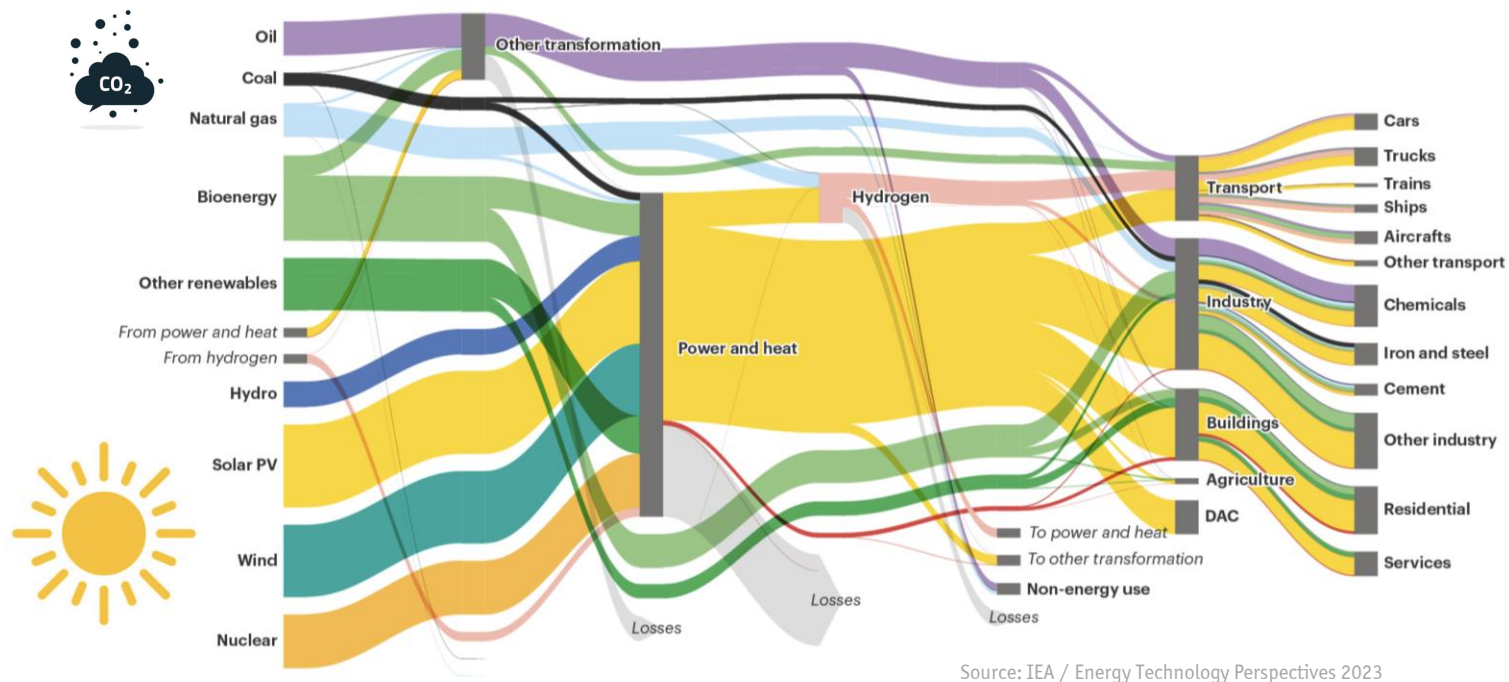

Dominant Share of Electric Energy — Power Electronics as Key Technology (!)

Remark New Disruptive Technologies (?)

- 2050 → No Fundamentally New Concepts Product-Ready in 20+ Years Time Frame (!)
- Main Barriers to Net-Zero Multi-Carrier Energy Systems Deployment are Social & Political & Institutional

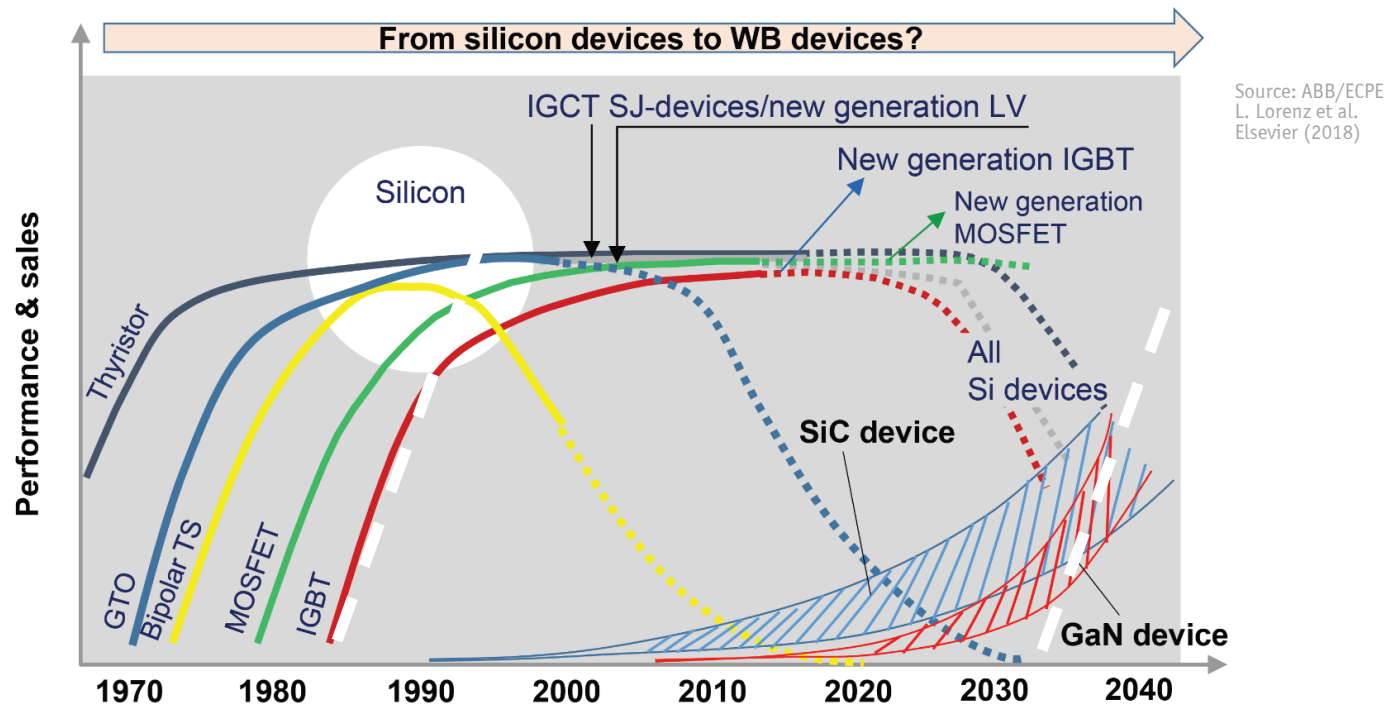

- E.g. 10...20 Years Introduction Phase of New Power Semiconductor Technologies

The in the Room — WHAT WE'RE NOT TALKING ABOUT

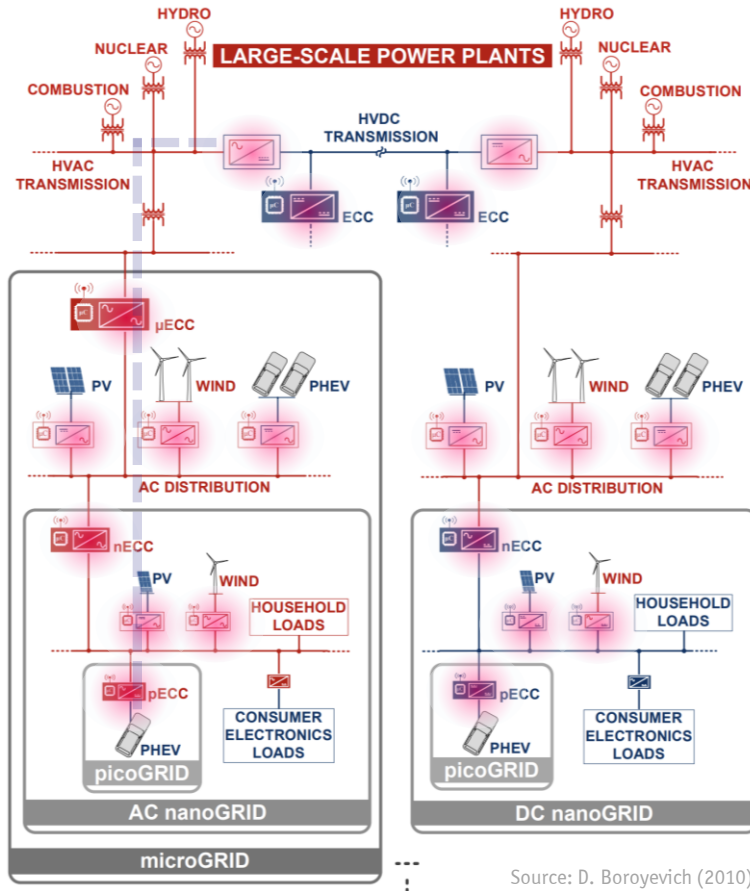

Source: D. Boroyevich (2010)

- 25'000 GW Installed Ren. Generation in 2050
- 15'000 GWh Batt. Storage
- 4x Power Electr. Conversion btw Generation & Load
- 100'000 GW of Installed Converter Power
- 20 Years of Useful Life



Source: www.e-waste-recyclers.co.in

- 5'000 GW_{eq} = 5'000'000'000 kW_{eq} of E-Waste / Year (!)
- 10'000'000'000 \$ of Potential Value

The in the Room — WHAT WE NEED TO TALK ABOUT !

- 52'000'000 Tons of Electronic Waste Produced Worldwide in 2021 → 74'000'000 Tons in 2030
- Increasingly Complex Constructions → No Repair or Recycling

Source: Green IT Solution

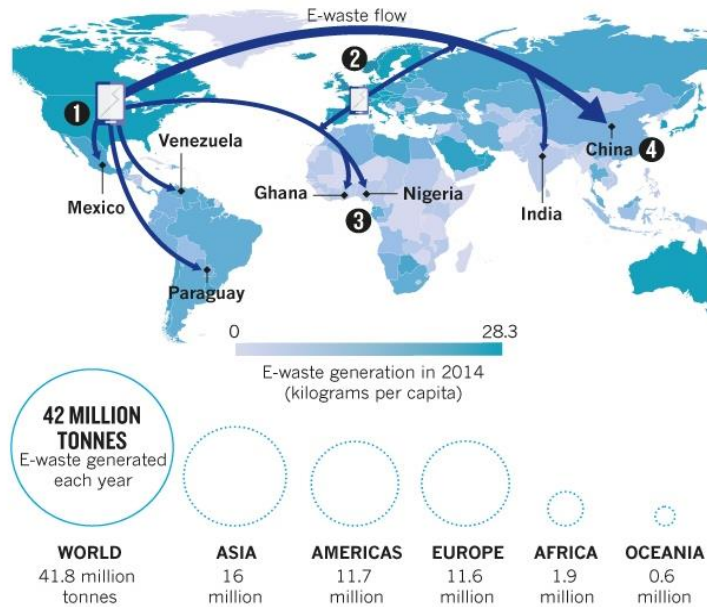

Source: nature

- Growing Global E-Waste Streams → Regulations Mandatory (!)

The Paradigm Shift (1)

- **Growing Global E-Waste Streams / < 20% Recycled**
- **120'000'000 Tons of Global E-Waste in 2050**

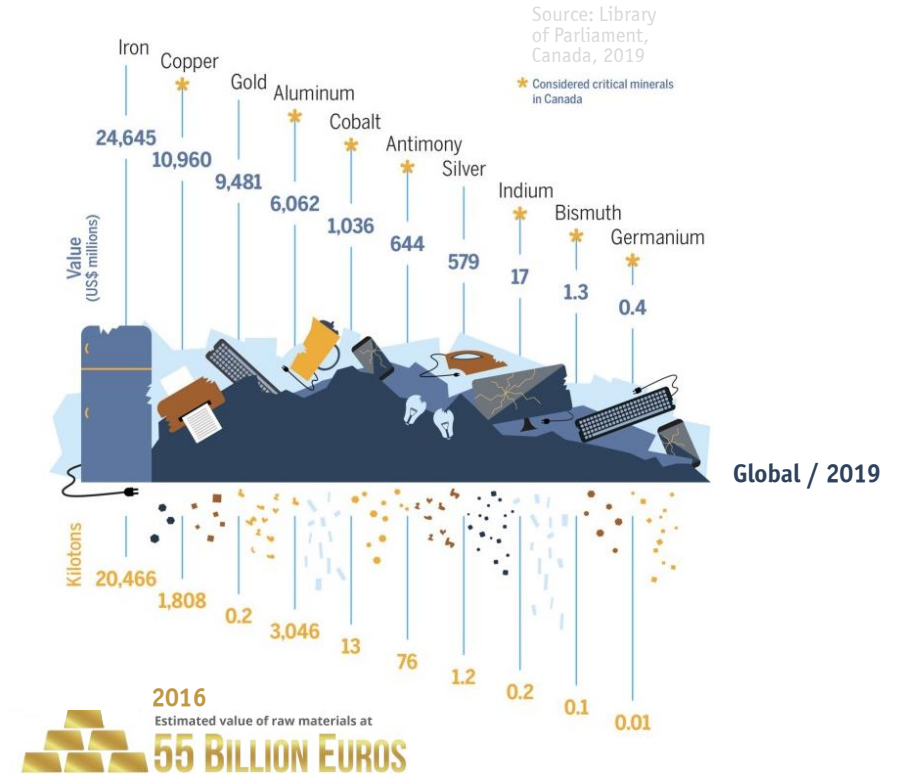

- **“Linear” Economy / Take-Make-Dispose → “Circular” Economy / Perpetual Flow of Resources**
- **Resources Returned into the Product Cycle at the End of Use**
- **E-Waste is an “Urban Mine” w/ Great Economic Potential**

The Paradigm Shift (2)

- Growing Global E-Waste Streams / < 20% Recycled
- 120'000'000 Tons of Global E-Waste in 2050

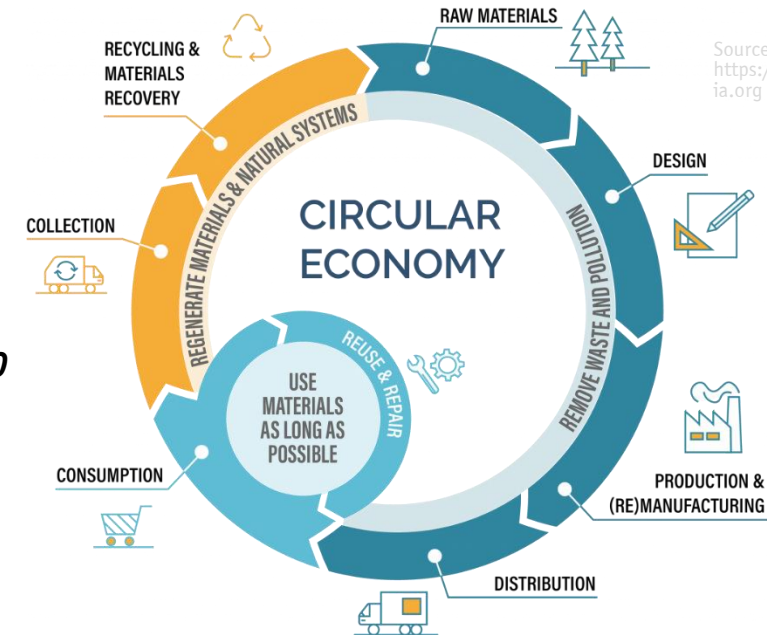

- “Linear” Economy / Take-Make-Dispose → “Circular” Economy / Perpetual Flow of Resources
- Resources Returned into the Product Cycle at the End of Use

Critical Minerals

■ Production of Selected Minerals Critical for the Clean Energy Transition

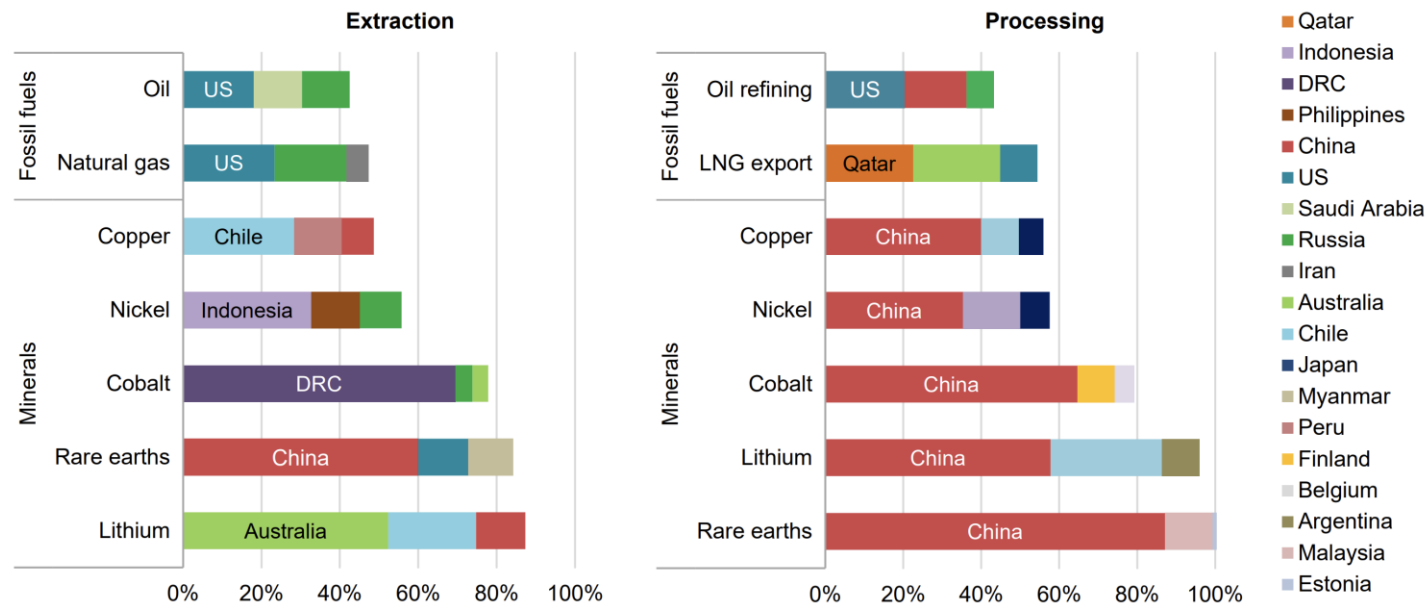

Source: IEA / The Role of Critical Minerals in Clean Energy Transitions (2021)

Shares of top three producing countries, 2019

■ Extraction & Processing More Geographically Concentrated than for Oil & Nat. Gas (!)

Complexity Challenge

- Technological Innovation — **Increasing Level of Complexity & Diversity of Modern Products**
- Exp. Accelerating Technological Advancement (R. Kurzweil)

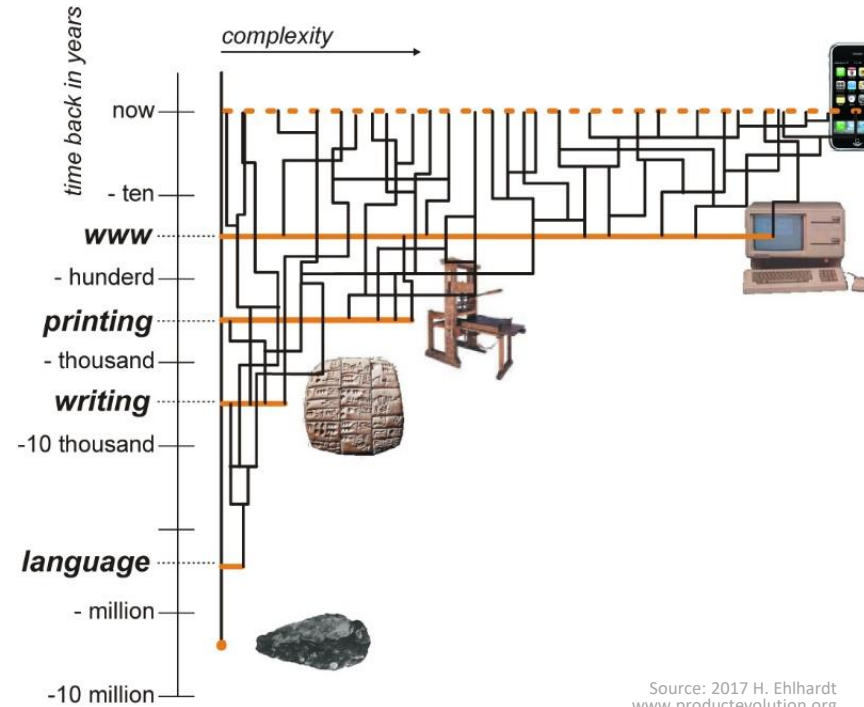

- **Ultra-Compact Systems / Functional Integration — Main Obstacle for Material Separation**

Design for Repairability & Circularity

- **Eco-Design** — Reduce Environmental Impact of Products, incl. Energy Consumption Over Life Cycle
- **Re-Pair / Re-Use / Disassembly / Sorting & Max. Material Recovery**, etc. Considered
- **EU Eco-Design Guidelines (!)**

Source: 

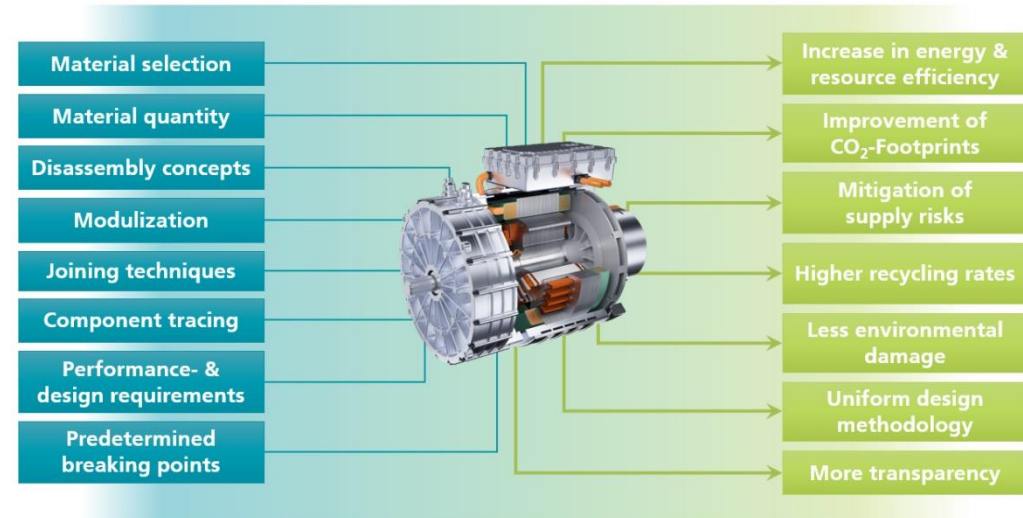

- **FAIRPHONE** — Modular Design | Man. Replaceable Parts | 100% Recycl. of Sold Products | Fairtrade Materials
- **80% of Sustainability / Environmental Impact of Products are Locked-In at the Design Phase**

Multi-Objective Optimization

- *Typ. Performance Indices* — Efficiency η [%] | Power Density ρ [kW/dm³] | Rel. Cost σ [kW/\$]
- *Consideration of Specific Operating Points OR Mission Profile*

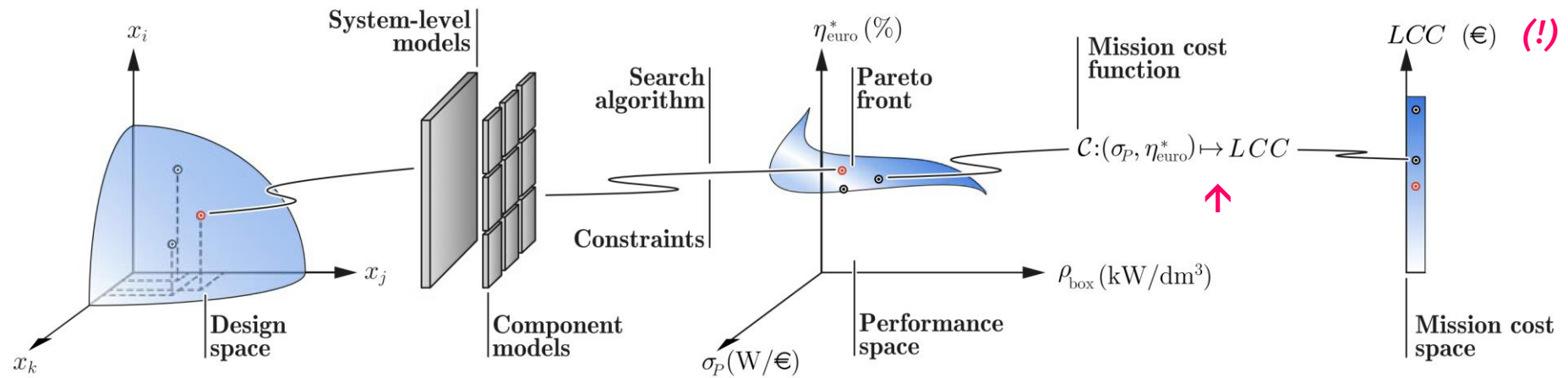

- *Mission Profile* — Power Loss \rightarrow Energy Loss / **Life-Cycle Cost (!)**

Design Space Diversity (1)

- Very Different Design Space Coordinates Map to Very Similar Performance Space Coordinates

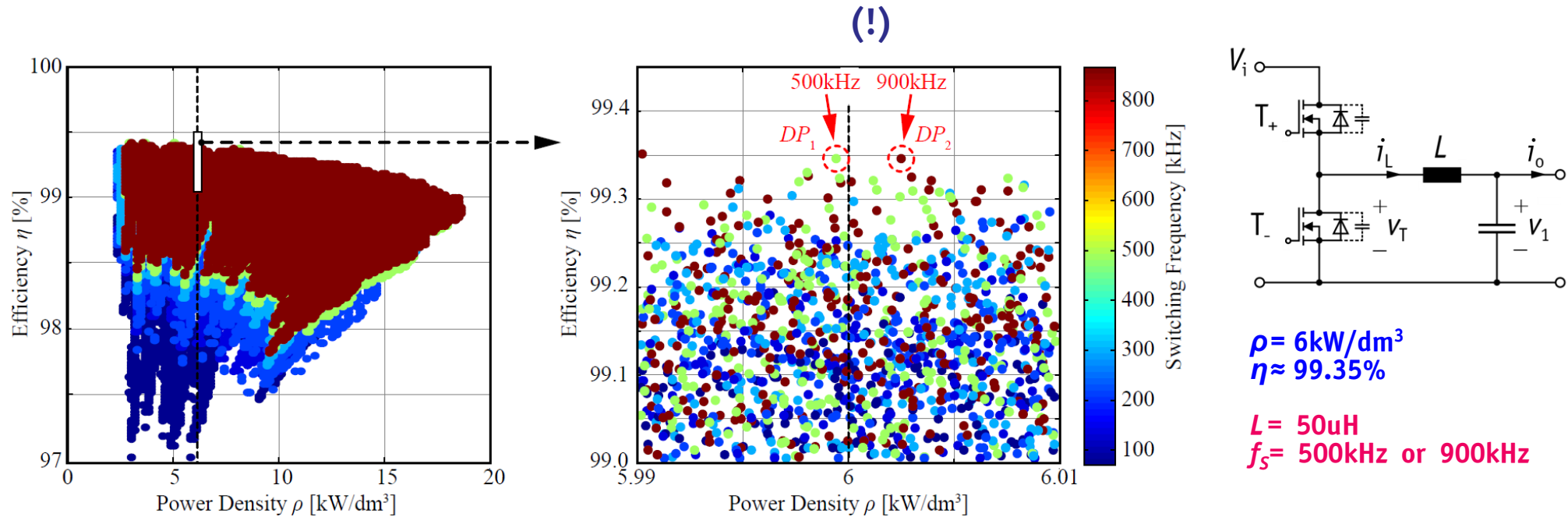

- Example of GOOGLE Littlebox Challenge 1.0 Design Optimization w/ PWM Operation & Ideal Switches
- Mutual Compensation of HF and LF Loss Contributions

Design Space Diversity (2)

- **Two Concepts / Similar Specs** — 12.5 kW, 650...720V_{DC}, CISPR 11 Class A — **Similar Performance ($\eta_{CEC} = 99.1\%$)**
- **Differences in Environmental Impact (?)**

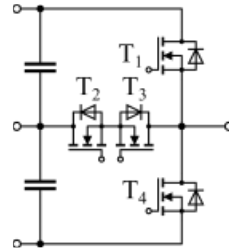

★ **3-Level All-SiC T-Type PV Inverter**
99.4% @ 2.4 kW/dm³

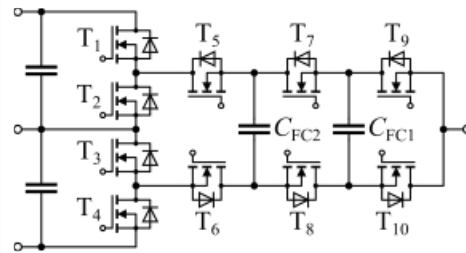

★ **7-Level All-Si HANPC PV Inverter**
99.35% @ 3.4 kW/dm³

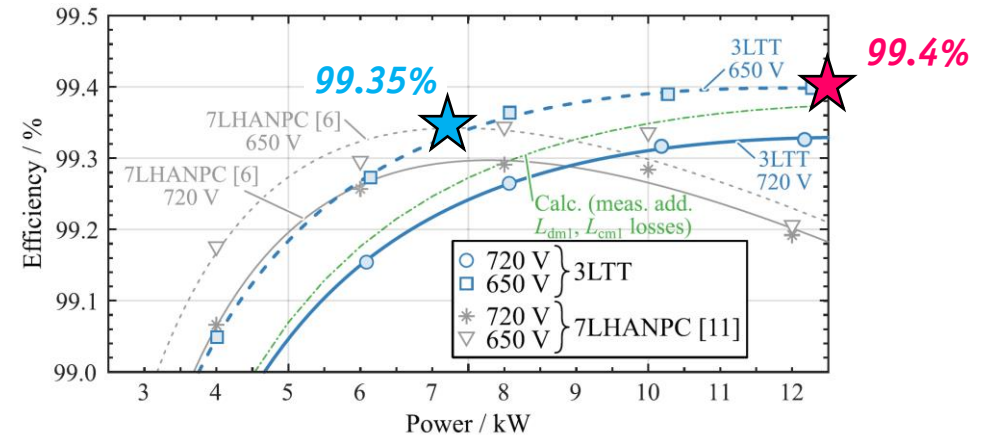
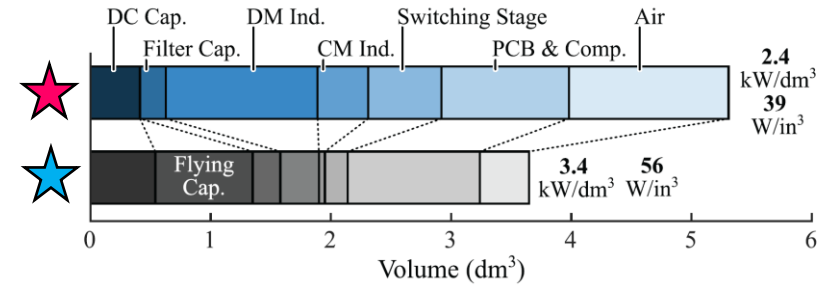

A-Posteriori LCA of 3L & 7L PV Inverters

- Two Concepts / *Similar Specs* — 12.5 kW, 650...720V_{DC}, CISPR 11 Class A — *Similar Performance* ($\eta_{CEC} = 99.1\%$)

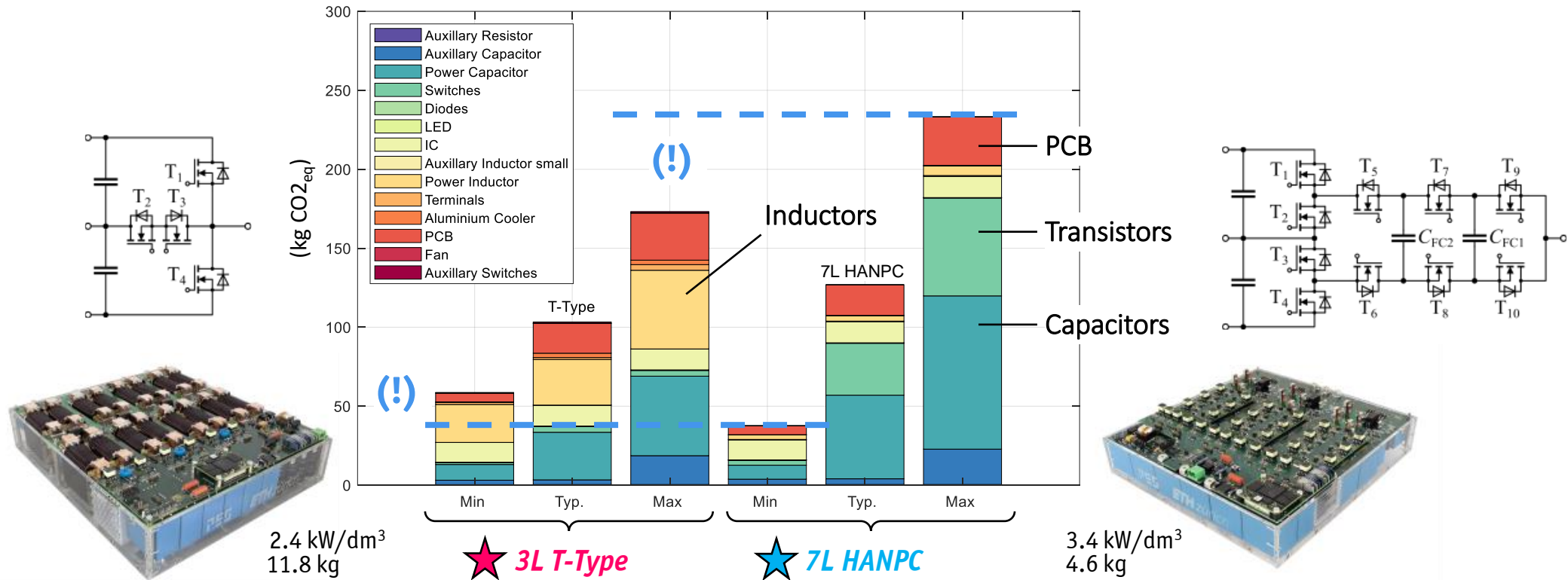

- Generic Compon. Models / *ecoinvent & Literature as Data Sources* → *Widely Varying Parameter Values / CO_{2eq}-Results*

New Holistic (!) Design Approach

*Multi-Objective Optimization w/
Environmental Impacts as New
Performance Indicators*



Example — Three-Phase AC/DC PEBB

- **Key Power Electronics Building Block (PEBB) for Three-Phase PFC Rectifiers & Inverters**

10 kW
 400 V_{AC} Mains
 800 V_{DC} Output
 1200 V SiC

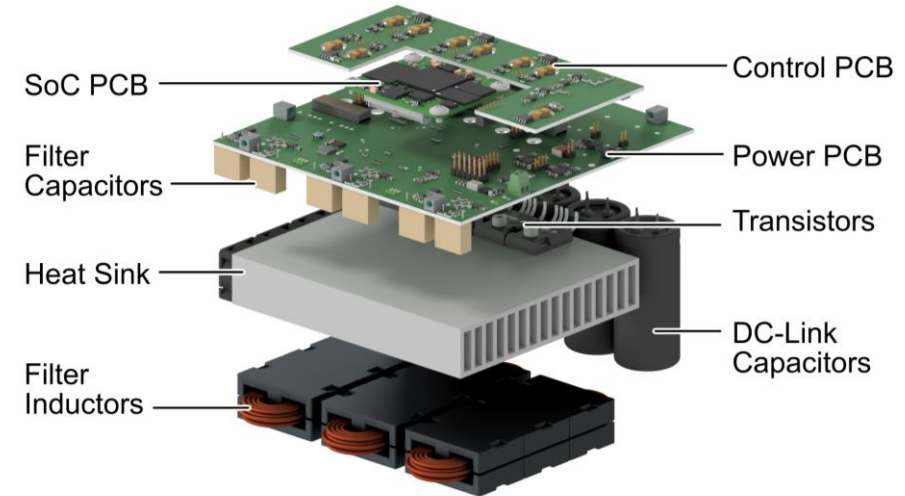
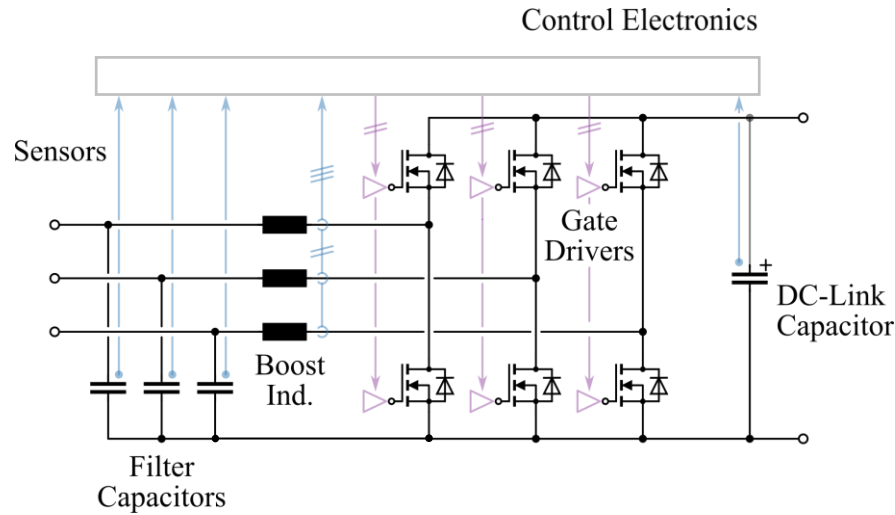

- **Main Components Considered (Losses, Volume, CO_{2eq})**
- **Power Trans., Heat Sink, Boost Ind., DC-Link Cap., Filter Cap., Gate Drivers, Sensors, Contr. Electr., PCBs**

η - ρ -Multi-Objective Optimization

- *Design Space Diversity — Optimiz. for Min. Environmental Impact w/o Compromising Eff. or Power Density (!)*
- *Example of a Three-Phase Two-Level AC-DC PEBB w/ LC-Input Filter*

10 kW
400 V_{AC} Mains
800 V_{DC} Output
1200 V SiC

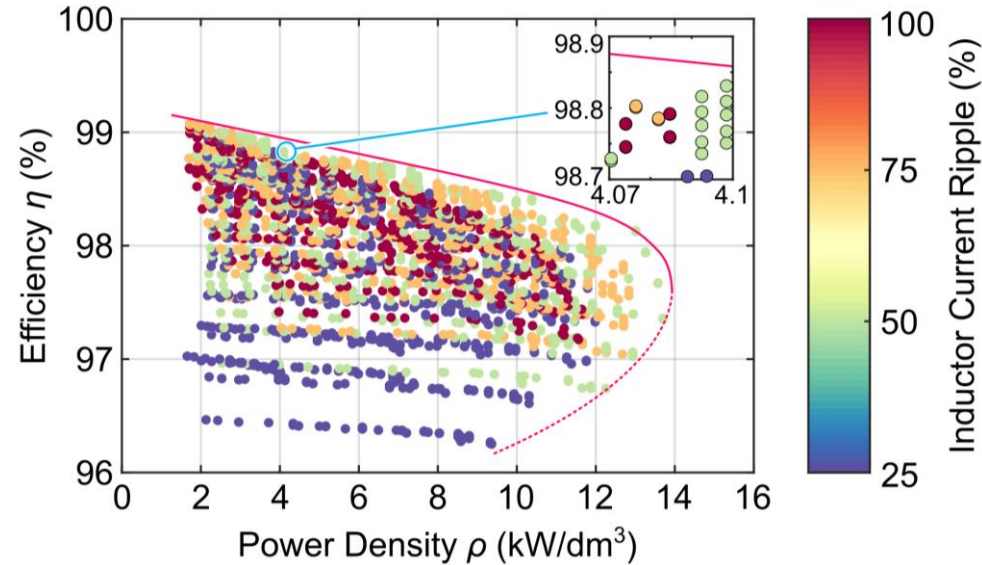

■ *Degrees of Freedom*

- *Switching Frequency [25...200 kHz]*
- *Rel. Ind. Peak Current Ripple [0.25...1]*
- *Variable Transistor Chip Area*
- *Variable Ind. Size (N87; Solid/Litz Wire)*

■ *Assumptions*

- *Junction Temp. @ 120 °C*
- *Ambient Temp. 40 °C*
- *Necessary Heat Sink Volume via CSPI = 25 W/(K·dm³)*

Efficiency vs. Operating Time Carbon Footprint

- **Global Warming Potential GWP [kg CO_{2eq}] as Add. Performance Indicator**
- **Mission Matters — Example 8 Hours Full Load per Day Over 10 Years**
- **Electricity Mix Matters — Carbon Intensity**

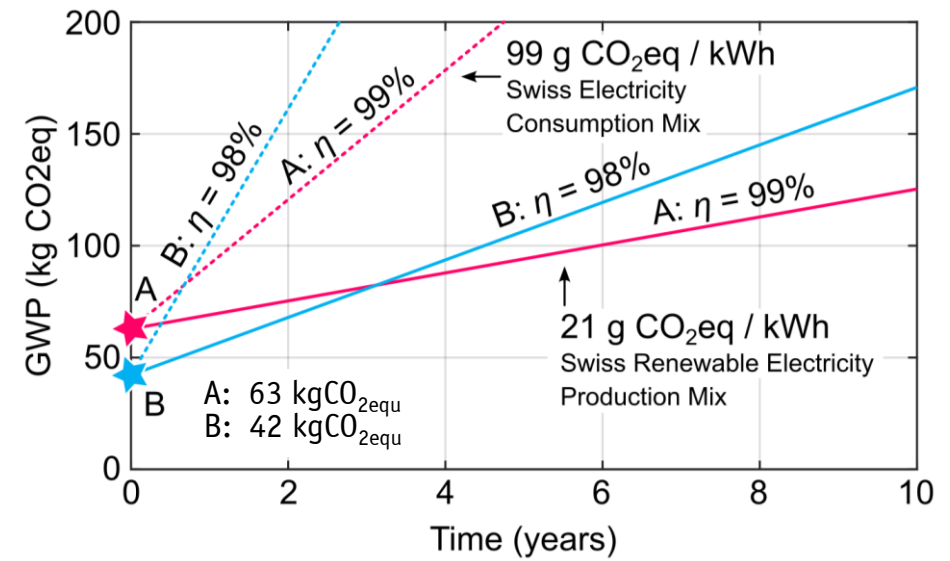
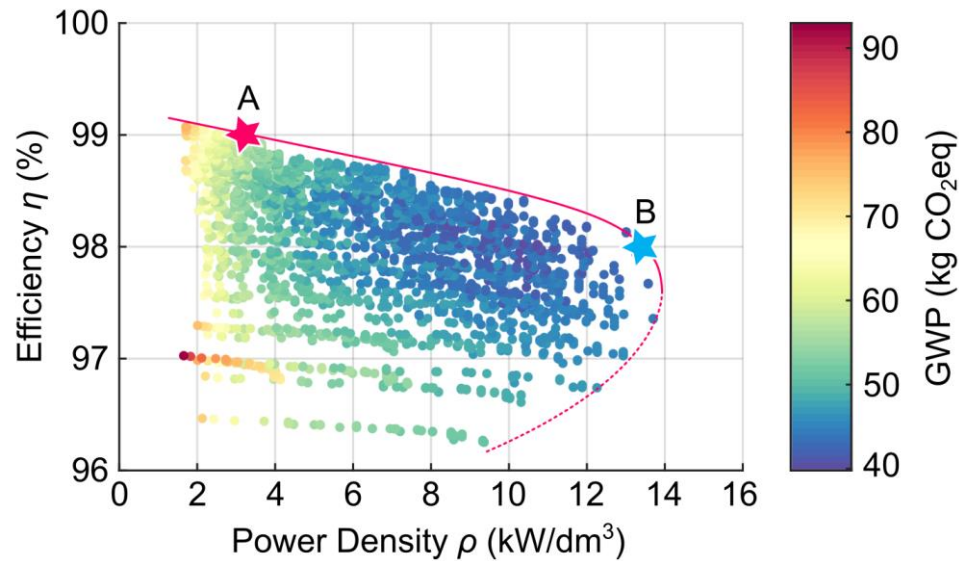

- **Energy Losses During Use Phase Contribute to Overall GWP**
- **More Eff. Designs w/ Higher Initial GWP Outperform Less Eff. Designs for Longer Operating Times**

2-Level vs. 3-Level PEBB Evaluation

- **3-Level Flying-Capacitor Bridge-Legs** w/ 650 V SiC MOSFETS / **2-Level Bridge-Legs** w/ 1200 V SiC MOSFETS
- 400 V_{AC} Mains | 800 V_{DC} | 10 kW | LC-Filter w/ Same Capacitor Voltage Ripple

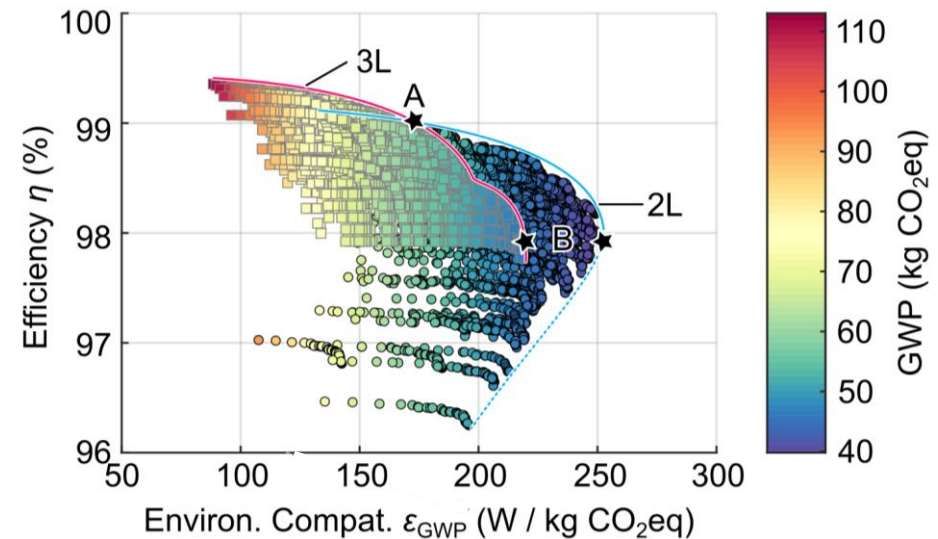
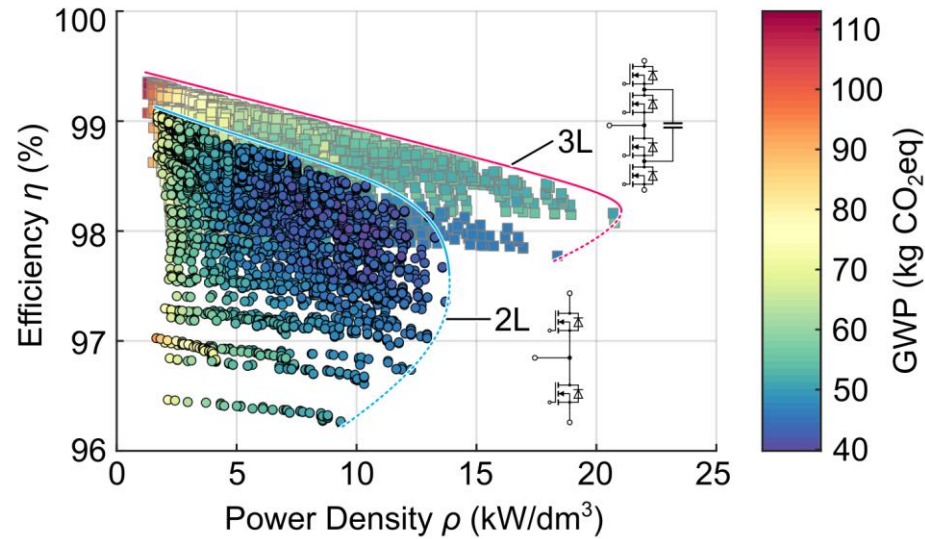

- **Higher 3L Inverter Eff. & Power Density BUT Lower Environm. Compatibility [W/kgCO_{2eq}]**
- **Higher 3L Initial GWP Due to Higher # of Power Semiconductors**

Comprehensive Environmental Impact Profile

- Further Environm. Impact Indicators / Volume & ReCiPe 2016 Areas of Protection
- Human Health | Ecosyst. Quality | Resource Scarcity
- Comparative Evaluation of 2L vs. 3L PEBB

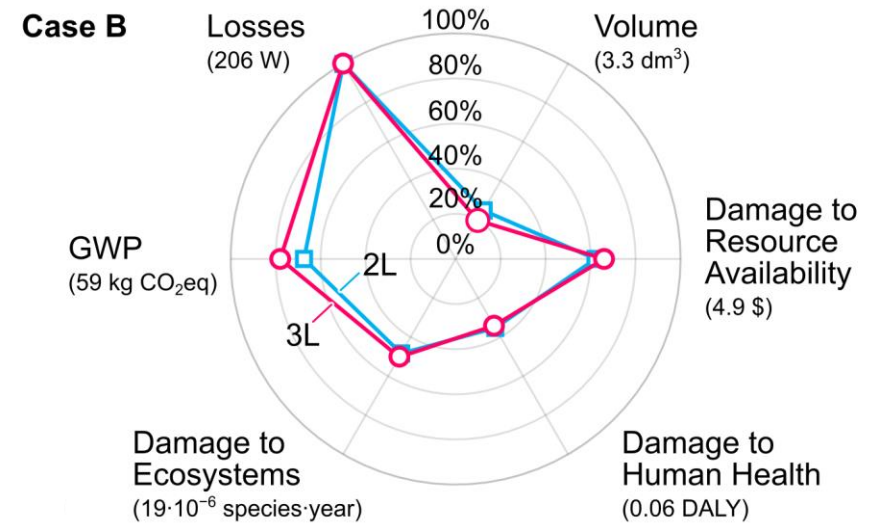
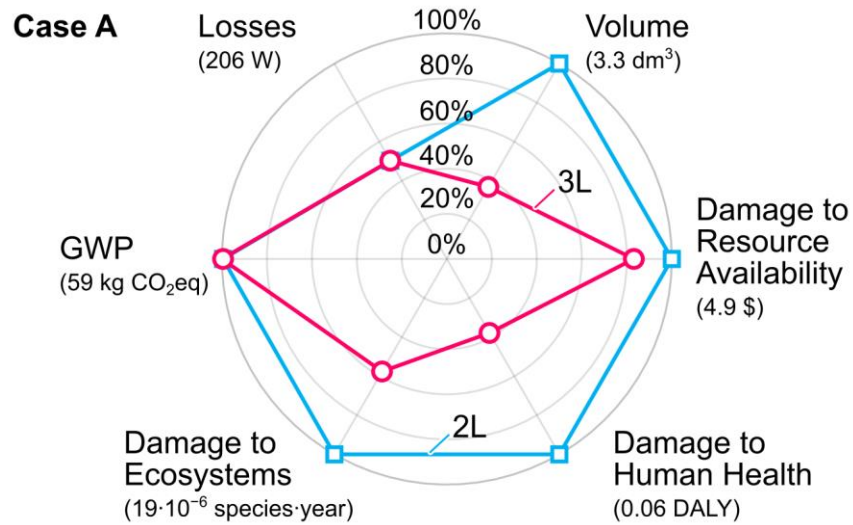

- Case A 99% Eff. @ Equal GWP — Significantly Diff. Volumes & Diff. ReCiPe Performance
- Case B 98% Eff. @ Highest Rel. Environm. Compatibility — Similar Volumes & Environm. Impacts

Future Performance Indicators

- Assuming 20+ Years Lifetime → Systems Installed Today Reach End-of-Life in 2050 (!)
- Life-Cycle Assessment (LCA) Mandatory for All Future System Designs

- Complete Set of New Performance Indicators

- Environmental Impact [kgCO₂eq/kW]
- Resource Efficiency [kg_{xx}/kW]
- Embodied Energy [kWh/kW]
- TCO [\$/kW]
- Power Density [kW/m²]
- Mission Efficiency [%]
- Failure Rate [h⁻¹]

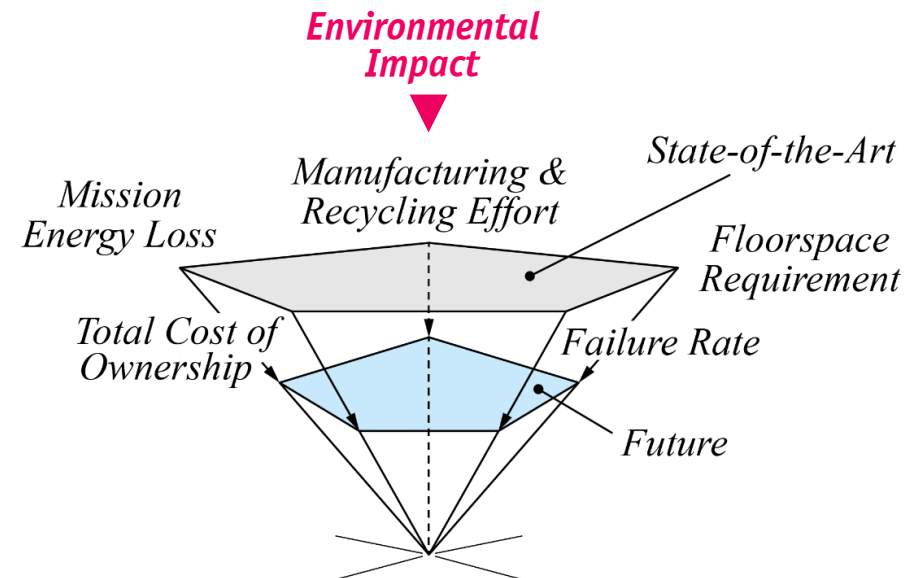

CEC-Power Electronics Roadmap

■ Environmental Awareness as Integral Part of Power Electronics Design

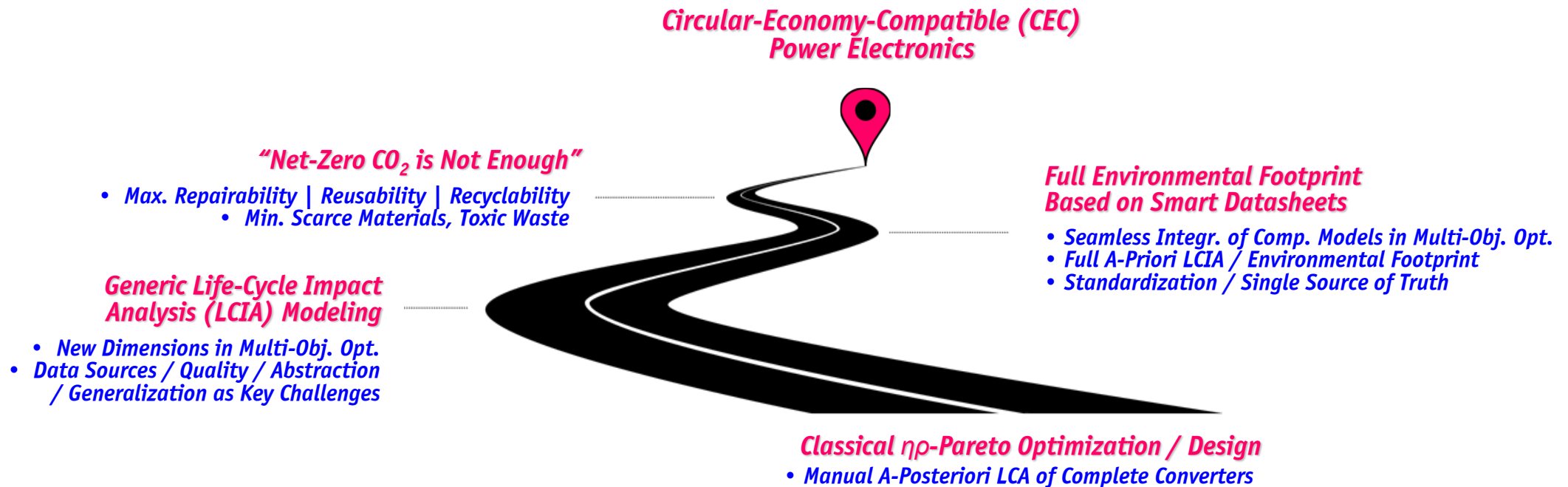

■ Automated Design | On-Line Monitoring | Prev. Maintenance | Digital Product Passport

Power Electronics 5.0

- Power Electronics 1.0 → Power Electronics 5.0
- X-Technologies & X-Concepts
- New Main Performance Indicators (!)

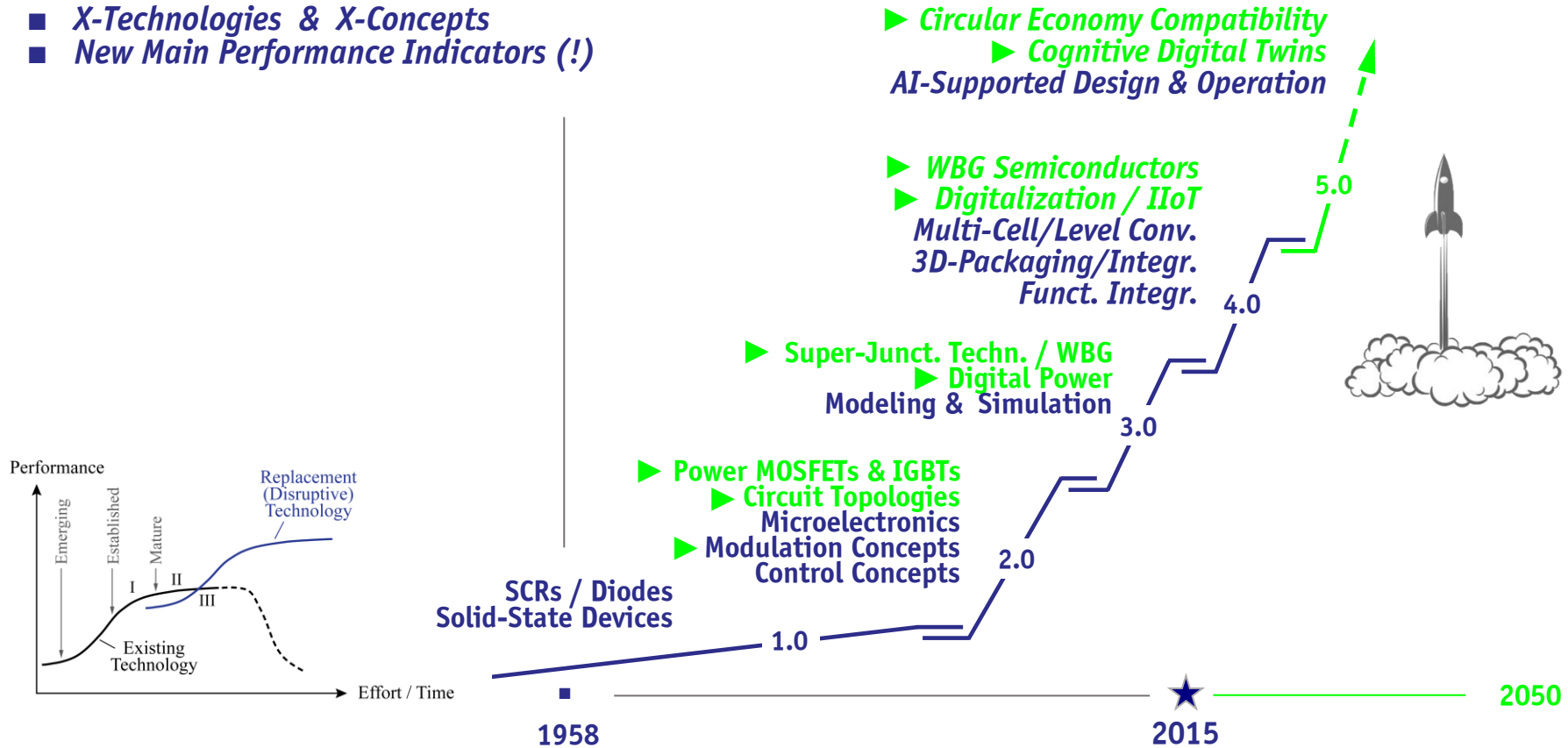

Thank You !

